



# Ticari İstihbarat ve Hedef Pazarda Müşteri Bulma Eğitimi

18.04.2024 / 14:00

Nevsal Zülküf Alhas  
[nevsal@tradeatlas.com](mailto:nevsal@tradeatlas.com)  
[www.linkedin.com/in/nevsal](https://www.linkedin.com/in/nevsal)

# Ticari İstihbarat

## Ne işe Yarar

# Kullanım

- Yeni müşteriler arama
- Yeni tedarikçiler arama
- Rakiplerin analizi
- Tedarikçi, müşteri ve bayilerin analizi
- Sektöre ilişkin durum analizi ve gelişmelerin takibi
- .....



# Ticari İstihbarat Verileri





# Ülkelere göre veriler

İTHALATÇI ÜLKE	Tarih	GTIP Kodu	Ürün Detayı	İthalatçı	İhracatçı	Fiyat	Ağırlık-Miktar	Mensel	DİL	2017	2018	2019	2020	2021	2022	2023	YÜKLEME SIKLIĞI	GECİKME	NOTLAR
ABD Konşimento	✓	✓	✓	✓	✓	-	✓	✓	İngilizce	✓	✓	✓	✓	✓	✓	✓	Aylık	~1 ay	Tüm ithalatçılar (deniz yoluyla)
Angola	✓	✓	-	✓	✓	✓	✓	✓	Portekizce	✓	✓	✓	✓	✓	✓	✓	Çeyreklik	~4 ay	Tüm ithalatçı firmalar (2020 itibariyle ihracatçı ismi mevcut)
Arjantin	✓	✓	✓	✓	-	✓	✓	✓	İspanyolca	✓	✓	✓	✓	✓	✓	✓	Aylık	~2 ay	Tüm ithalatçı firmalar (İhracatçı ismi Marka kolonunda)
Avrasya Ekonomik Birliği	✓	✓	✓	✓	✓	✓	✓	✓	Rusça / İngilizce	-	-	-	-	-	✓	✓	Aylık	~2 ay	İthalatçı firmalar (Belarus, Ermenistan, Kazakistan, Kırgızistan, Rusya)
Bangladeş	✓	✓	✓	✓	✓	✓	✓	✓	Çoklu dil	-	-	-	✓	✓	✓	✓	Aylık	~2 ay	Tüm ithalatçı firmalar
Bolivya	✓	✓	✓	✓	✓	✓	✓	✓	İspanyolca	✓	-	-	-	-	-	-	-	-	Tüm ithalatçı firmalar
Botsvana	✓	✓	✓	✓	✓	✓	✓	✓	İngilizce	-	-	-	✓	✓	✓	✓	Aylık	~3 ay	Tüm ithalatçı firmalar (2021'den itibaren fiyat ve kısmi ürün detayı)
Brezilya	✓	✓	-	✓	✓	-	✓	✓	Portekizce	✓	✓	✓	-	-	-	-	-	-	Tüm ithalatçı firmalar (büyük kısmı ihracatçı ismi içerir)
Brezilya Konşimento	✓	✓	✓	✓	✓	-	✓	✓	Portekizce	-	✓	✓	✓	✓	✓	✓	Aylık	~3 ay	Tüm ithalatçılar (deniz yoluyla)
Çad	✓	✓	✓	✓	✓	✓	✓	✓	Çoklu dil	-	-	-	✓	✓	-	-	-	-	İthalatçıların önemli bir bölümü
Ekvator	✓	✓	✓	✓	✓	✓	✓	✓	İspanyolca	✓	✓	✓	✓	✓	✓	✓	Aylık	~2 ay	Tüm ithalatçı firmalar
Endonezya	✓	✓	✓	✓	✓	✓	✓	✓	İngilizce	✓	✓	✓	✓	✓	-	-	-	-	Tüm ithalatçı firmalar (2021 Eylül'e kadar)
Etiyopya	✓	✓	-	✓	-	✓	✓	✓	İngilizce	✓	✓	✓	✓	✓	✓	✓	Aylık	~1 ay	Tüm ithalatçı firmalar
Fas	✓	✓	-	✓	-	-	-	-	Çoklu dil	✓	-	-	✓	✓	✓	-	Yıllık	~15 ay	Tüm ithalatçı firmalar
Fiji	✓	✓	✓	✓	✓	✓	✓	✓	İngilizce	-	-	-	-	✓	-	-	Aylık	~12 ay	Tüm ithalatçı firmalar
Fildişi Cumhuriyeti	✓	✓	✓	✓	✓	✓	✓	✓	Fransızca	-	✓	✓	✓	✓	✓	✓	Aylık	~1 ay	Tüm ithalatçı firmalar
Filipinler	✓	✓	✓	✓	✓	✓	✓	✓	İngilizce	✓	✓	✓	✓	✓	✓	✓	Aylık	~2 ay	Tüm ithalatçı firmalar

# Yansıtma Veri ve Konşimento

RU → IQ

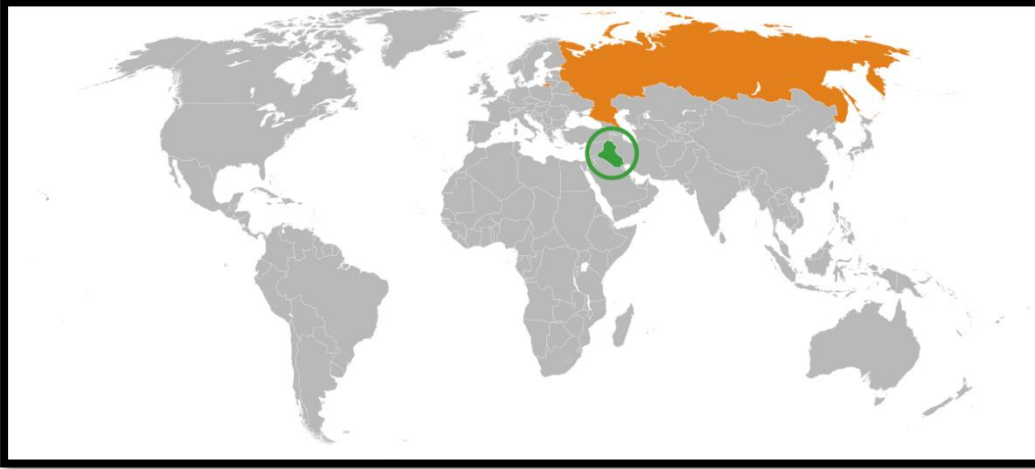

IN → DE

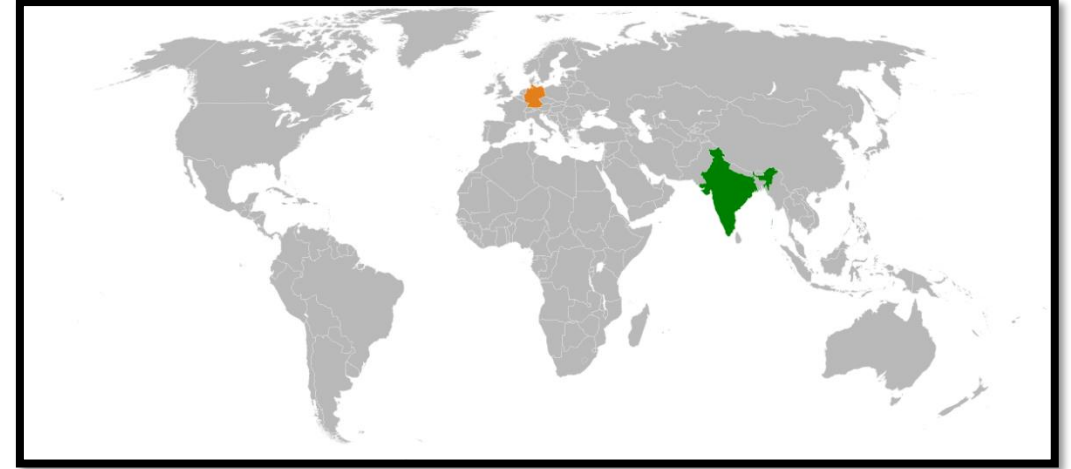

CN → FR









# TradeMap vs. Ticari İstihbarat

# Örnek

- Yıl : 2020
- İhracatçı ülke : Ukrayna
- İthalatçı ülke : İtalya
- GTİP : 441872 – Birleştirilmiş Döşeme Tahtalarından Panolar



# TradeMap: 1 milyon \$

Home & Search Data Availability Reference Material Other ITC Tools More

Product ... 441872 - Flooring panels, multilayer, assembled, o

World  Country **Ukraine**

Partner **Italy**

other criteria Exports Yearly time series by product At the same level (6 digits) Values US Dollar

Existing and potential trade between  
Product: 441872 Flooring panels, multilayer, assembled  
The product code selected above has been removed from the list

Unit: US Dollar thousand

Table Graph Map Companies

Download: [Icons]

HS8	Product code	Product label	Ukraine's exports to Italy		
			Value in 2018	Value in 2019	Value in 2020
	441875	Flooring panels, multilayer, assembled, of wood other than bamboo (excl. for mosaic floors)	0	0	1,624
	441872	Flooring panels, multilayer, assembled, of wood (excluding for mosaic floors)	3,390	3,442	1,004
	441899	Builders' joinery and carpentry, of wood, incl. cellular wood panels (excl. of bamboo, windows, ...)	0	0	610
	441890	Builders' joinery and carpentry, of wood, incl. cellular wood panels (excluding windows, French ...)	1,346	1,516	357
	441820	Doors and their frames and thresholds, of wood	278	176	197
	441873	Flooring panels, assembled, of bamboo or with at least the top wear layer of bamboo	0	0	68



# Ticari İstihbarat: 1.003.294,48 \$

TARİH	İHRACATÇI FİRMA (Ukrayna)	İTHALATÇI FİRMA (İtalya)	DEĞER (\$)	MİKTAR (kg)
26-06-2020	ПП МЕЛЛУДА ВУЛ	PIANA S R L	11.607,95	3.003,00
03-03-2020	ПП МЕЛЛУДА ВУЛ	ITALIAN PARQUET S R L	41.460,23	12.719,00
17-01-2020	ТОВ ВУДСТОК	TRADE WOOD COMPANY SRL	6.330,85	2.025,00
31-01-2020	ТОВ ТАНДЕМ ІМПЕКС УКРАЇНА	Labor Legno Srl	54.735,06	21.121,00
14-02-2020	ТОВ ТАНДЕМ ІМПЕКС УКРАЇНА	CENTRO PARQUET Srl	23.185,36	8.050,00
...	...	...	...	...
...	...	...	...	...
...	...	...	...	...
...	...	...	...	...
...	...	...	...	...
...	...	...	...	...
...	...	...	...	...
TOTAL			1.003.294,48	340.216,00



# Örnek Analizler

 MIDROC  
INVESTMENT  
GROUP  
Ethio Agri-CEFT P.v.Ltd.Co.  
Etiyopya

Average purchase price  
**6,7 \$ / kg**

  
Etiyopya

Average purchase price  
**5,4 \$ / kg**

 Ibrahim Hussien  
Coffee Exporter  
Etiyopya

Average purchase price  
**5,9 \$ / kg**



# Dalmayr

Alois Dalmayr  
Germany

ETHIOPIAN CROWN  
**20,4 \$ / kg**

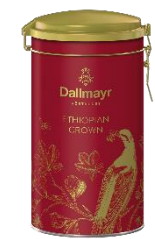

Paraguay



BRAR TEXTILE

HS : 521142  
Route : China -> Vietnam

**TCE** **VINA DENIM**

HS : 521142  
Route : Vietnam -> USA

**DKNY**  
DONNA KARAN NEW YORK



ComAfrique  
LIMITED

COMAFRIQUE EXPORTS  
Gambiya



ST. MARY'S CASHEW  
Hindistan



OMNITRADE  
HANDELSGESELLSCHAFT MBH

OMNITRADE  
Almanya



Average price  
**100-120 \$ / ton**



Average price  
**600-800 \$ / ton**



# Sistemde Arama

# Veritabanında nasıl arama yapılır?

ARAMA ----->	Firma ismi	Ürün tanımı	GTİP kodu
İthalatçılar	✓	✓	✓
İhracatçılar	✓		

EK DEĞİŞKENLER	Sevkiyat tarihi	Kalkış ve varış limanı	İhracatçı ve ithalatçı ülke	Marka
----------------	-----------------	------------------------	-----------------------------	-------



# Notlar

# Firma Arama

# Firma Arama

HUAWEI INTERNATIONAL

HUAWEI INTERNATIONAL CO LIMITED

HUAWEI INTERNATIONAL CO LTD

HUAWEI INTERNATIONAL CO. LIMITED

HUAWEI INTL CO LTD

.....

IKEA HOLDING BV -> IKEA SUPPLY AG

.....

MAGNUM (marka) -> UNILEVER (resmi firma ismi)

.....

TEXTILE, LEATHER, SOLAR

.....

GÜMRÜKÇÜ / Kişi İSMİ / BANKA....



# Notlar

# Ürün Arama

# Ürün Arama

IPHONE 14  
MOBILE PHONE  
CELL PHONE  
CELL PH.  
C. PHONE  
SMART PHONE  
SMARTPHONE

.....

MARKA VE FİRMA İSİMLERİNİ  
ÜRÜN OLARAK ARAMA

.....

ALTERNATİF DİLLER \*\*\*

MOUSE



# Farklı dillerdeki beyannameler

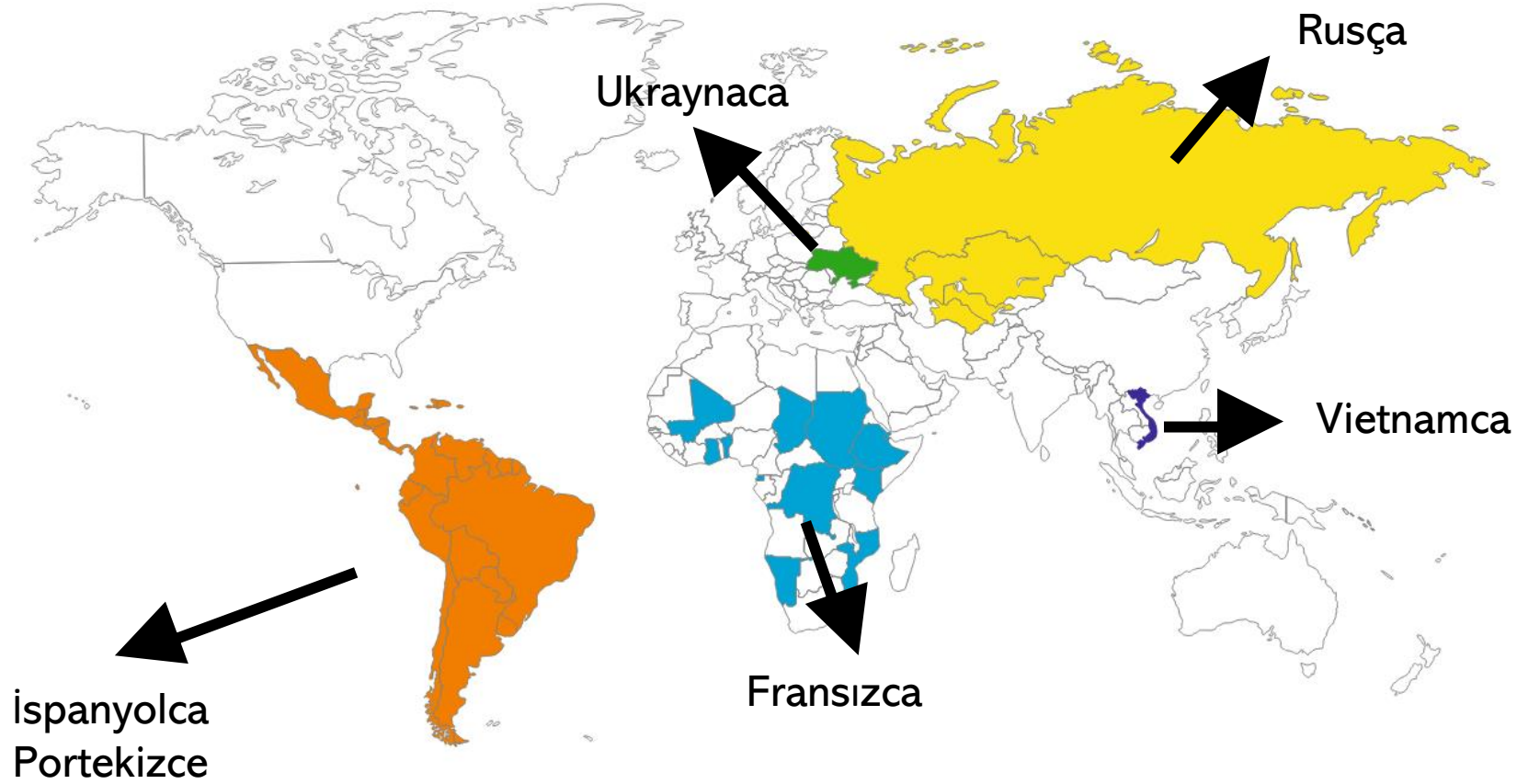

TR	Domates
ENG	tomato
RUS	помидор
UKR	помідор
VIE	cà chua
ESP POR	tomate
FRA	tomate





# Notlar

# GTiP Arama

# GTİP Kodları

11.22.33.44.55.66

6-hane (global)

12-haneye kadar (ülkeler)

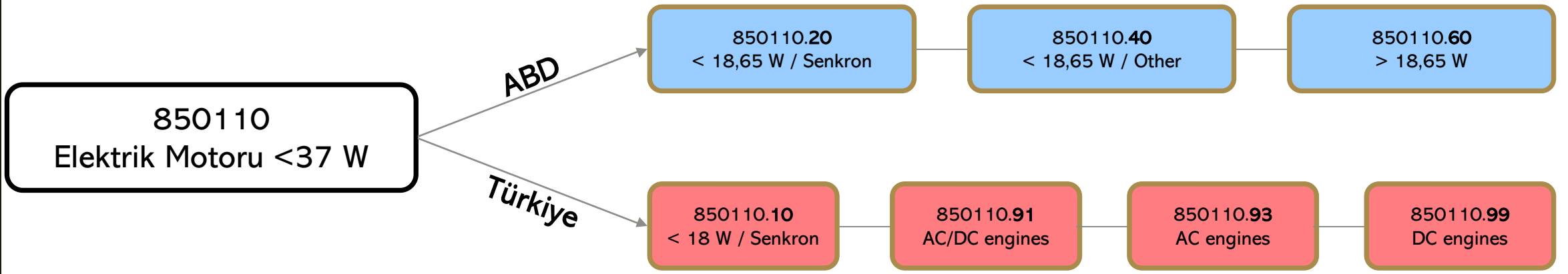

# 6'lı GTİP kodları örneği

07 02 00 : Domates (taze veya soğutulmuş)

15 09 10 : Saf zeytinyağı

85 16 31: Saç kurutucuları

01 06 90 : Diğer canlı hayvanlar

55 12 99 : Sentetik devamsız liflerden dokunmuş diğer mensucat

84 26 19: Vinçler



# Notlar

# Türev Aramalar

# Benzer ve Tamamlayıcı Ürünler

Benzer



~



Tamamlayıcı



+



# Girdi Çıktı Analizi

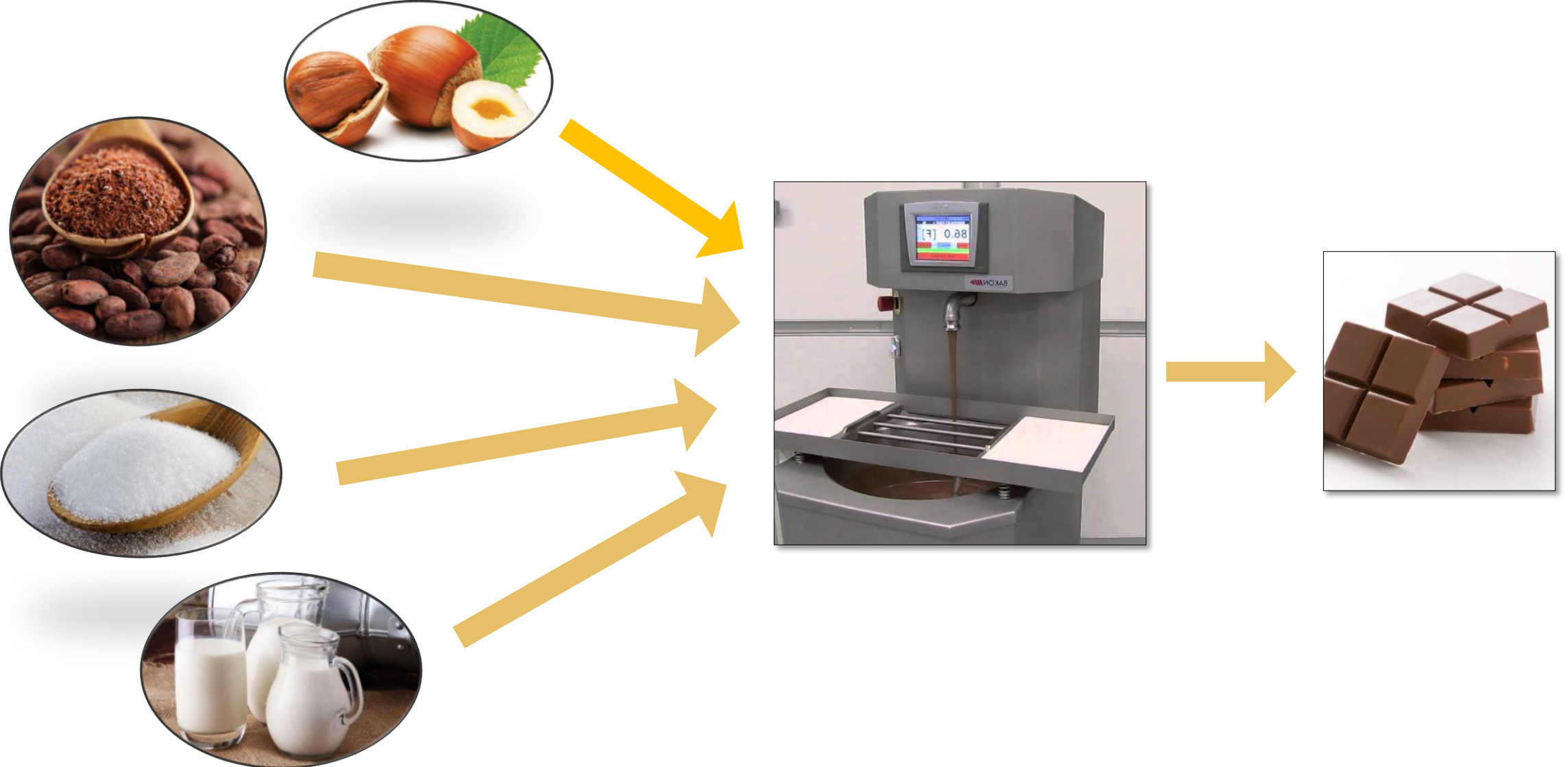

# Tedarik Zinciri Çözümü

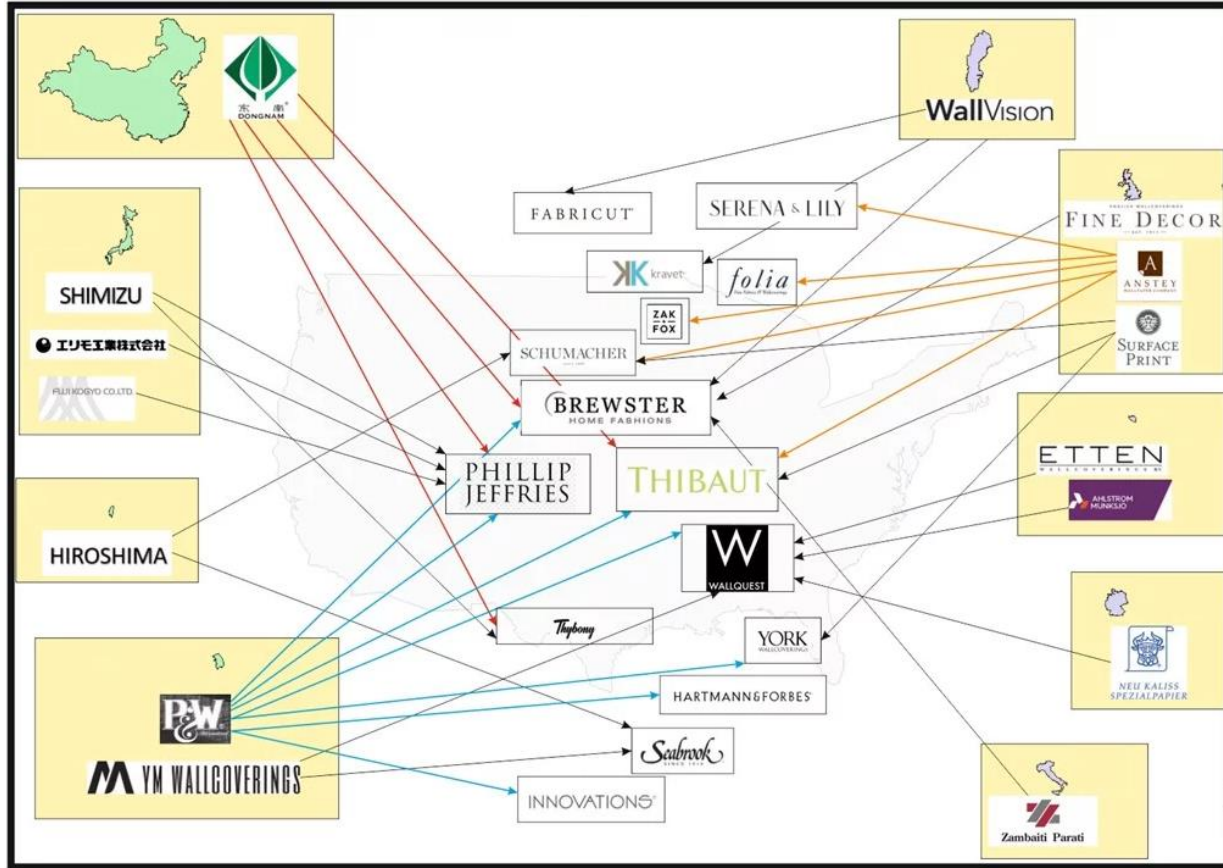

ihracatçı X1



ithalatçı M1

ihracatçı X2



ithalatçı M2

ihracatçı X3



ithalatçı M3

ihracatçı X4



ithalatçı M4



# Eğitimden Örnek Veriler





# Konteyner

NO	ARRIVAL DATE	HS CODE	HS CODE DESCRIPTION	IMPORTER NAME	IMPORTER ADDRESS	IMPORTER COUNTRY	CITY STATE	TEL	FAX	E-MAIL	WEB	EXPORTER NAME	EXPORTER ADDRESS	COUNTRY OF ORIGIN	IMPORT VALUE FOB	IMPORT VALUE CIF	CU
1	31-12-2023	94069090	Other	SRI MAGOD LASER	.	Hindistan	India	.	.	.	https://ww	YIWU WOOGLE IMPORT & EXPORT CO.,LTD	.	Çin	0	95 US	
2	31-12-2023	94069090	Other	SRI MAGOD LASER	.	Hindistan	India	.	.	.	https://ww	YIWU WOOGLE IMPORT & EXPORT CO.,LTD	.	Çin	0	35 US	
3	31-12-2023	94069090	Other	SRI MAGOD LASER	.	Hindistan	India	.	.	.	https://ww	YIWU WOOGLE IMPORT & EXPORT CO.,LTD	.	Çin	0	400 US	
4	31-12-2023	94069030	Loài khác	MR. SANTISOUK SAYASENH	.	Laos	Lao Peopl	.	.	.	.	Nguyễn Thị Nhung	13B Ông k	Vietnam	1,7E+08	0 VN	
5	31-12-2023	940690	Buildings	AL RYADA MARITIME CO	.	Libya	Libya	.	.	.	https://alr	NINGBO CHIAO FENG SHIPPING CO. LTD.	.	Çin	0	0	
6	31-12-2023	940690	Buildings	TRANSMA DOM	.	Martinique (FR)	Martiniqu	.	.	.	.	HUNICORN SHIPPING CO. LTD	.	Çin	0	0	
7	31-12-2023	940690	Buildings	AUCHAN MAGYARORSZAG KFT.	.	Slovenya	Slovenia	.	.	.	https://ww	DHL GLOBAL FORWARDING (HK) LTD O/B	.	Çin	0	0	
8	31-12-2023	94069090	Autres	KAYITESI BEATRICE	.	Burundi	Burundi	.	.	.	.	WEIHI ADVERTISEMENT GIFT PRINTING	.	Kenya	90866868	90866868 BIF	
9	31-12-2023	940620		IVINDO IRON SA	.	Gabon	Gabon	.	.	.	.	BOLT MODULAR PTY LTD	.	Güney Afrika Cumhu	0	0	
10	31-12-2023	940620		IVINDO IRON SA	.	Gabon	Gabon	.	.	.	.	BOLT MODULAR PTY LTD	.	Güney Afrika Cumhu	0	0	
11	31-12-2023	940600	Buildings	KAFNAM COMPANY LTD.	PLOT 4379	Gana	Ghana	.	.	.	https://ww	JAYA IMPEX,	.	Hindistan	0	0	
12	31-12-2023	94069030	Loài khác	FIBER PAPERTECH ENGINEERING & TRADING LTD.	UNIT NOS	Endonezya	Indonesia	.	.	.	.	Công ty TNHH Kirby Đông Nam á	KCN Nhotr	Vietnam	76924	0 US	
13	31-12-2023	940690	Buildings	PT. MEGAYASA TEKNOLOGI INDONESIA	.	Endonezya	Indonesia	.	.	.	.	MICRO SHELTER SOLUTION	.	Fransa	0	0	
14	31-12-2023	94069090	Other	SRI MAGOD LASER	.	Hindistan	India	.	.	.	https://ww	YIWU WOOGLE IMPORT & EXPORT CO.,LTD	.	Çin	0	415 US	
15	31-12-2023	94069090	Other	SRI MAGOD LASER	.	Hindistan	India	.	.	.	https://ww	YIWU WOOGLE IMPORT & EXPORT CO.,LTD	.	Çin	0	169 US	
16	31-12-2023	94069090	Other	SRI MAGOD LASER	.	Hindistan	India	.	.	.	https://ww	YIWU WOOGLE IMPORT & EXPORT CO.,LTD	.	Çin	0	12 US	
17	31-12-2023	94069090	Other	SRI MAGOD LASER	.	Hindistan	India	.	.	.	https://ww	YIWU WOOGLE IMPORT & EXPORT CO.,LTD	.	Çin	0	86 US	
18	31-12-2023	940690	Buildings	UNICEF POUR ONG TECHNIDEV	.	Kamerun	Cameroor	.	.	.	.	SHENZHEN SHENGCHENG TRADING CO. LTD	.	Çin	0	0	
19	31-12-2023	940620		IVINDO IRON SA	.	Gabon	Gabon	.	.	.	.	BOLT MODULAR PTY LTD	.	Güney Afrika Cumhu	0	0	
20	31-12-2023	940620		IVINDO IRON SA	.	Gabon	Gabon	.	.	.	.	BOLT MODULAR PTY LTD	.	Güney Afrika Cumhu	0	0	
21	31-12-2023	94069030	Loài khác	PT BANGUN ESTETIKA LESTARI	JL MH TH/	Endonezya	Indonesia	.	.	.	.	Công ty TNHH Kirby Đông Nam á	KCN Nhotr	Vietnam	20083	0 US	
22	31-12-2023	94069030	Loài khác	MR. SANTISOUK SAYASENH	.	Laos	Lao Peopl	.	.	.	.	Nguyễn Thị Nhung	13B Ông k	Vietnam	1,2E+08	0 VN	
23	31-12-2023	940690	Buildings	CHINA JIANGSU CONSTRUCTION	.	Mauritius	Mauritius	.	.	.	.	CHINA JIANGSU INTERNATIONAL	.	Çin	0	0	
24	31-12-2023	940690	Buildings	AUCHAN MAGYARORSZAG KFT.	.	Slovenya	Slovenia	.	.	.	https://ww	DHL GLOBAL FORWARDING (HK) LTD O/B	.	Çin	0	0	
25	31-12-2023	940690	Buildings	GOLDEN KING INVESTMENT CO	.	Tanzanya	Tanzania	.	.	.	.	TAIAN LUNENG IMP&EXP CO LTD	.	Çin	0	0	
26	31-12-2023	940690	Buildings	GOLDEN KING INVESTMENT CO	.	Tanzanya	Tanzania	.	.	.	.	TAIAN LUNENG IMP&EXP CO LTD	.	Çin	0	0	
27	31-12-2023	940620		IVINDO IRON SA	.	Gabon	Gabon	.	.	.	.	BOLT MODULAR PTY LTD	.	Güney Afrika Cumhu	0	0	
28	31-12-2023	94069030	Loài khác	FIBER PAPERTECH ENGINEERING & TRADING LTD.	UNIT NOS	Endonezya	Indonesia	.	.	.	.	Công ty TNHH Kirby Đông Nam á	KCN Nhotr	Vietnam	71280	0 US	
29	31-12-2023	94069090	Other	SRI MAGOD LASER	.	Hindistan	India	.	.	.	https://ww	YIWU WOOGLE IMPORT & EXPORT CO.,LTD	.	Çin	0	20 US	
30	31-12-2023	940690	Prefabrice	KAMIYAMA FACTORY CO.LTD	345-51 AM	Japonya	Japan	.	.	.	.	FUTURE BUILDINGS	1405 DENI	Kanada	0	0	
31	31-12-2023	940690100	Other greo	OCEAN AGRICULTURE (E.A.)LTD.	.	Kenya	Kenya	.	.	.	https://oc	Haygrove Limited	.	İngiltere	0	10716627 KE	
32	31-12-2023	940690	Buildings	CHINA JIANGSU CONSTRUCTION	.	Mauritius	Mauritius	.	.	.	.	CHINA JIANGSU INTERNATIONAL	.	Çin	0	0	
33	31-12-2023	94069030	Loài khác	MR. SANTISOUK SAYASENH	.	Laos	Lao Peopl	.	.	.	.	Nguyễn Thị Nhung	13B Ông k	Vietnam	1,2E+08	0 VN	



# GTIP: 830242

NO	ARRIVAL DATE	HS CODE	HS CODE DESCRIPTION	IMPORTER NAME	IMPORTER ADDRESS	IMPORTER COUNTRY	CITY STATE	TEL	FAX	E-MAIL	WEB	EXPORTER NAME	EXPORTER ADDRESS	COUNTRY OF ORIGIN	IMPORT VALUE FOB	IMPORT VALUE CIF	CURCY
1	31-01-2023	8302420000	Base Metal Mountings, Fittings And Similar Articles Suitable For Furniture	OOO TDP	Г. СУХУМ.	Abkhazya Bölgesi	Abkhazia					ИП ИВАНКОВ ДМИТРИЙ НИКОЛАЕВИЧ	344015, PC Rusya	Russia	96.63	-	USD
2	31-01-2023	83024200	Other, suitable for furniture	INTERMETAL LLC.		Birleşik Arap Emirlikleri	United Arab Emirates				https://int	INGLOBE EXPORTS	59/60,UDY Hindistan	Hindistan	207.40	-	USD
4	31-01-2023	83024200	Other, suitable for furniture	INTERPLAST COMPANY LTD.		Birleşik Arap Emirlikleri	United Arab Emirates				http://www	INGLOBE EXPORTS	59/60,UDY Hindistan	Hindistan	8.21	-	USD
6	31-01-2023	83024200	Other, suitable for furniture	THAPA ENTERPRISE			Bhutan					MUKESH ENTERPRISE	.... Hindistan	Hindistan	7.650,00	-	INR
8	31-01-2023	830242	Mountings, Fittings And Similar Articles ( Except Hinges And C	RENIN CANADA CORP.	110 WALKER	Canada	ON - Brampton				https://www	JIANGSU YUEXIN HOME DECORATION CO.,	NO.756,Zh Güney Kore	Güney Kore	-	-	
9	31-01-2023	83024200	Other, suitable for furniture	PRIME DECORATIVE HARDWARE, INC.			Canada				https://www	KELCO INDUSTRIES	AJI GDIC P Hindistan	Hindistan	47.50	-	CAD
10	31-01-2023	83024210	EMPUNADURAS, MANIJAS (MANILLAS), PARA MUEBLES	LEOPOLDO JAIRO MUNOZ VARGAS			Chile						Türkiye	Türkiye	7.723,38	8.362,47	USD
11	31-01-2023	8302420090	Other	ТОВ ПАНЦІЛІОН ВУЛ АХАЙМОЦАМЕТА № 52 РАЙОН			Georgia					ПРИВАТНЕ АКЦІОНЕРНЕ ТОВАРИСТВО СВІТ МЕБЛІВ УКРАЇНА 2	Ukrayna	Ukrayna	72.00	-	UAH
12	31-01-2023	83024200	Base Metal Mountings, Fittings And Similar Articles Suitable For Furniture	ALBAGINO MARKETING & TRADE CO.LTD.			Israel					SRL "OCS-PRIM" MOLDOVA, MUN. CHISIN	Moldova	Moldova	185.814,00	-	MDL
13	31-01-2023	83024200	Other, suitable for furniture	GHANSHYAM PAINTS & HARDWARE MART.	8 Umija Sh	Hindistan	Mehasana	91942635		hmodif67@	https://www	SHIVAM INTERNATIONAL (HK) CO., LIMITED	Çin	Çin	-	741.00	USD
14	31-01-2023	83024200	Other, suitable for furniture	EBCO PVT. LTD.	Saki Vihar I	Hindistan	Mumbai.M	28575889	28571342	ebco@vsnl	https://eb	GUANGDONG TUTTI HARDWARE CO.,LTD.	Çin	Çin	-	2.589.00	USD
16	31-01-2023	83024200	Other, suitable for furniture	EBCO PVT. LTD.	Saki Vihar I	Hindistan	Mumbai.M	28575889	28571342	ebco@vsnl	https://eb	FOSHAN SHUNDE HEQIAN PRECISION MANU	Çin	Çin	-	11.363.00	USD
18	31-01-2023	83024200	Other, suitable for furniture	EBCO PVT. LTD.	Saki Vihar I	Hindistan	Mumbai.M	28575889	28571342	ebco@vsnl	https://eb	TRUECHOICE HARDWARE CO., LIMITED...	Çin	Çin	-	8.096.00	USD
19	31-01-2023	83024200	Other, suitable for furniture	EBCO PVT. LTD.	Saki Vihar I	Hindistan	Mumbai.M	28575889	28571342	ebco@vsnl	https://eb	ZHAOQING CITY GAOYAO DISTRICT CHUAN	Çin	Çin	-	1.881.00	USD
20	31-01-2023	83024200	Other, suitable for furniture	ACTUAL BLOOS		Hindistan	India					MAHOTKAT INTERNATIONAL	Çin	Çin	-	752.00	USD
21	31-01-2023	83024200	Other, suitable for furniture	HARDWYN INDIA LTD.		Hindistan	India				https://www	JIEYANG SANLONG HARDWARE CO LTD	Çin	Çin	-	1.560.00	USD
22	31-01-2023	83024200	Other, suitable for furniture	AUBERGINE DESIGNWORKS LLP.		Hindistan	India				https://www	FURNITAL S.R.L	VIA MANZC İtalya	İtalya	-	396.00	EUR
30	31-01-2023	83024200	Other, suitable for furniture	RUDRAKSH TERMINAL LLP.		Hindistan	India					PROSTAR EXPORTS LIMITED	NA Çin	Çin	-	6.975.00	USD
31	31-01-2023	83024200	Other, suitable for furniture	GODREJ & BOYCE MFG. CO. LTD.,		Hindistan	Mumbai.M	67963201		rdc@godre	https://www	ETERNAL MARK PVT. LTD.	Çin	Çin	-	1.445.00	USD
34	31-01-2023	83024200	Other, suitable for furniture	ARIHANT IMPEX.		Hindistan	Bangalore				http://arih	PHOENIX NEST (SHANDONG) CRAFTS CO	Çin	Çin	-	3.120.00	USD
35	31-01-2023	83024200	Other, suitable for furniture	CRYSTAL INTERIOR PRODUCTS PVT. LTD.		Hindistan	Surat/Gujst	0261-2841		evershinec	http://ever	HENG GUANG TRADING CO.LIMITED	Çin	Çin	-	6.058.00	USD
39	31-01-2023	83024200	Other, suitable for furniture	Diwa Impex		Hindistan	IN - India					SONGXING CO., LIMITED	Çin	Çin	-	2.550.00	USD
42	31-01-2023	83024200	Other, suitable for furniture	PAG INTERNATIONAL PVT. LTD.		Hindistan	R.No.5,49/		22426026		https://www	ZHENJIANG INSTECH HARDWARE CO.,LTD	Çin	Çin	-	928.00	USD
43	31-01-2023	83024200	Other, suitable for furniture	INOX DECOR PVT.LTD.,		Hindistan	B1/1/2, M/			info@inox	https://www	RANSON INTERNATIONAL CORP.	Çin	Çin	-	1.872.00	USD
44	31-01-2023	83024290	Other	NIHON SANGYO CO.LTD.		Japonya	262-21 SH				https://www	SCAD SERVICES PTE., LTD.	BRANCH E Filipinler	Filipinler	21.969.89	-	USD
47	31-01-2023	83024200	OTHER BASE METAL MOUNTINGS, FITTINGS AND SIMILAR ARTI	MODERN FITTINGS MART KENYA LTD.	95575 801	Kenya	Kenya				https://rit	HAFELE SE &amp; CO KG	Almanya	Almanya	19.077.96	-	KES
48	31-01-2023	83024200	OTHER BASE METAL MOUNTINGS, FITTINGS AND SIMILAR ARTI	JANTS KENYA CO LTD.	52369 002	Kenya	Kenya				https://www	ZheJiang Maxwell International Trading Co.Limited	Çin	Çin	235.477,07	-	KES
49	31-01-2023	83024200	OTHER BASE METAL MOUNTINGS, FITTINGS AND SIMILAR ARTI	TILE & CARPET CENTRE LTD.	PARKSIDE	Kenya	Kenya				https://tite	HETTICH INDIA PRIVATE LIMITED	Almanya	Almanya	44.033,12	-	KES
50	31-01-2023	83024200	OTHER BASE METAL MOUNTINGS, FITTINGS AND SIMILAR ARTI	P.g Bison LTD.		Kenya	Kenya					ITALIANA FERRAMENTA SRL	İtalya	İtalya	354.022,56	-	KES
51	31-01-2023	8302420000	крепежная арматура, фурнитура и аналогичные детали, про	ТОО "ЕН-7"		Kazakistan	KZ - Kazakst					YIWU CITY QIANZI TRADE CO., LIMITED	КИТАЙNOI Çin	Çin	16.538.828,78	-	KZT
52	31-01-2023	8302420000	Base Metal Mountings, Fittings And Similar Articles Suitable For Furniture	TOO WORLDG3_VNL		Kazakistan	DINMUKH					CONFOX BAUMASCHINEN GMBH	Almanya	Almanya	442,20	-	EUR
53	31-01-2023	830242	Mountings, Fittings And Similar Articles ( Except Hinges And C	LTD LIABILITY PARTNERSHIP MF-ALMATY	R/N ALATAI	Kazakistan	Kazakhstan					MONSOON INTERNATIONAL LIMITED	ROOM 401 Çin	Çin	26.428,20	-	USD
54	31-01-2023	8302420000	крепежная арматура, фурнитура и аналогичные детали, про	ТОО ART-МЕБЕЛЬ 01		Kazakistan	Kz, T.Алма				https://art	HONG DA TRADING LIMITED	КИТАЙ71 I Çin	Çin	89.936,92	-	KZD
58	31-01-2023	83024200	Mountings, Fittings And Similar Articles ( Except Hinges And C	SAHASARA INTERNATIONAL (PVT) LTD.	NO.31/2, C	Sri Lanka	LK - Sri Lan				http://www	HONGKONG ANGELA TRADE CO.,LIMITED	Rm 4, 16/F Çin	Çin	-	80.00	USD
59	31-01-2023	83024200	Mountings, Fittings And Similar Articles ( Except Hinges And C	PACIFIC INTERNATIONAL P L	46/5, Oute	Sri Lanka	Sri Lanka					EMAX INTERNATIONAL	No. 09, Apr Hindistan	Hindistan	-	6.58	USD
60	31-01-2023	83024290000	Other Mountings, Fittings And Similar Articles suitable for furn	NEW INTERIOR DECORATOR PTY LTD.	MAIN SOU' Lesoto	Lesoto	Lesotho				https://www	IMPACT PLUS TRADING	BLOEMFOI Güney Afrika Cumhuriyeti	Güney Afrika Cumhuriyeti	7.481,00	7.481,00	LSL
61	31-01-2023	830242000	Altele, pentru mobilă	OCIS-PRIMSRL	MD-2012J	Moldova	Moldova					ALBAGINO MARKETING AND TRADE CO. LT	İsrail	İsrail	185.177,00	-	MDL
63	31-01-2023	83024203	Los demás, para muebles.	WOODCRAFTERS HOME PRODUCTS S. DE R.L. DE C.V.	CARRETER	Meksika	Mexico-Ri						Meksika	Meksika	5.913,73	-	USD
64	31-01-2023	83024291	Cerraduras sin llave, picaportes o pasadores.	DUPONT MEXICO, S.A. DE C.V.	Homero, 2	Meksika	Mexico-Tle				https://www	dupont.mx	Amerika Birleşik Devletleri	Amerika Birleşik Devletleri	156,40	-	USD



# Food preparations

ARRIVAL DATE	HS CODE	HS CODE DESCRIPTION	IMPORTER NAME	IMPORTER ADDRESS	IMPORTER COUNTRY	CITY STATE	TEL	FAX	E-MAIL	WEB	EXPORTER NAME	EXPORTER ADDRESS	COUNTRY OF ORIGIN	IMPORT VALUE FOB	IMPORT VALUE CIF	CURRENCY
31-07-2023	21069035	Food prep	NTS HOLDINGS PROPRIETARY LTD.	.	Botswana	Botswana	.	.	.	https://nt	PICK AND PAY DC	.	Güney Afrika Cumhu	15,35	179,05	USD
31-07-2023	21069090	Food prep	Delight Express Proprietary LTD	.	Botswana	Botswana	.	.	.	.	MBARE MUSIKA MARKET	.	Zimbabve	19,82	56,99	USD
31-07-2023	210690	Food prep	A ORDRE DE	.	Kongo Cumhuriyeti	Congo	.	.	.	https://or	SOCIETE INDUSTRIELLE LESAFFRE	.	Fransa	-	-	
31-07-2023	210690	Food prep	Emkay Foods CO	10 Aziz Ab	Mısır	Egypt	.	.	.	http://ww	CREMIO JSC	.	Yunanistan	-	-	
31-07-2023	21069099	Other	MENZBEK CO. LTD.	Box 5527	Gana	Ghana	.	.	.	http://ww	CHEMCOPIA INGREDIENTS PRIVATE LIMITED	L - 501 Bl	Hindistan	4.687,20	-	USD
31-07-2023	21069099	Food prep	CAYETANO MOLICO	.	Ekvator Ginesi	Equatoria	.	.	.	.	RITAMAT MULTI CONCEPT LIMITED	.	Nijerya	-	-	
31-07-2023	210690170	Disacchar	CLICKS STORES LESOTHO PTY LTD.	P.O. BOX 7	Lesoto	Lesotho	.	.	.	https://cli	NEW CLICKS SOUTH AFRICA	CNR SEAR	Güney Afrika Cumhu	188,19	216,42	LSL
31-07-2023	21069099	Other	ALL MED DISTRIBUTORS LTD.	.	Mauritius	Mauritius	.	.	.	https://ww	OMICRON PHARMA PRIVATE LIMITED	....	Hindistan	162,00	-	USD
31-07-2023	210690920	OTHER	TOP FOODS LIMITED	P O BOX 5	Malavi	Malawi	.	.	.	.	HANDYWARE INDUSTRIES	36 SUNBE	Güney Afrika Cumhu	80.409.711,44	-	MWK
31-07-2023	21069090	Outras	WOOLWORTHS MOZAMBIQUE LTDA	.	Mozambik	Mozambic	.	.	.	https://ww	WOOLWORTHS (PTY) LTD	.	Güney Afrika Cumhu	966,00	1.192,87	MZN
31-07-2023	21069090	other fooc	AFRICAN MARKETING PTY LTD	PO BOX 90	Namibya	Namibia	.	.	.	https://ww	UNILEVER SOUTH AFRICA PTY LTD/nP.O.BOX 1091/nDURBAN/n400	.	Güney Afrika Cumhu	8.894,00	9.259,08	USD
31-07-2023	210690960	Food sup	CLARION MEDICALS LTD.	.	Nijerya	Nigeria	.	.	.	https://cle	THE MADRAS PHARMACEUTICALS	.	Hindistan	22.859.059,00	26.515.857,00	NGN
31-07-2023	210690950	Preparatic	SIBLINI NIG LTD.	45 OLUSE	Nijerya	Nigeria	.	.	.	http://inte	ANVERALLY & SONS PVT LTD	.	Sri Lanka	12.782.940,00	15.012.251,00	NGN
31-07-2023	210690960	Food sup	MEDHEIGHTS PHARMACY LTD.	.	Nijerya	Nigeria	.	.	.	https://mc	VITABiotics LIMITED	.	İngiltere	191.997.678,00	204.844.456,00	NGN
31-07-2023	210690920	Extracts, e	CHI LTD.	.	Nijerya	Nigeria	.	.	.	https://ww	INCAL AGRICOLA SRL	.	İtalya	11.235.576,00	12.425.526,00	NGN
31-07-2023	210690100	Special	UNICEF SOUTH SUDAN TOTO CHAN COMPOUND,ADDIS	.	South Sudan	South Sud	.	.	.	.	KE INSTA PRODUCTS(EPZ)LTM 1231-00606 EPZ ATHI RIVER MACHAI	.	Kenya	-	1.768.622.863,00	UGX
31-07-2023	21069099	OTHER FO	TECHNO RELIEF SUDAN LTD	.	South Sudan	South Sud	.	.	.	.	ORIENTAL WEA VERS CARPET	.	Çin	728,99	755,93	USD
31-07-2023	21069099	Other	BULAND SUPERMARKET LTD.	P.O.BOX 2	Tanzanya	Tanzania	.	.	.	http://ww	VIPUL DOSHI & CO.	504,JAISIN	Hindistan	512,00	-	USD
31-07-2023	210690300	Food sup	VINE PHARMACEUTICALS LTD.	.	Uganda	Uganda	.	.	.	.	PHARMA CONNECT NIGERIA	.	Nijerya	-	758.633,00	UGX
31-07-2023	210690200	Other fooc	U-FRESH ENTERPRISE LTD.	.	Uganda	Uganda	.	.	.	https://ww	NINGBO TRADEWIN IMP & EXP CO., LTD	.	Çin	-	4.566.748,42	UGX
31-07-2023	210690900	Other	JAI AMBE IMPEX LTD.	.	Uganda	Uganda	.	.	.	https://ww	AUZAT EXPORT (OPC) PRIVATE LIMITED	.	UNIVERSIT	-	2.264.689,00	UGX
31-07-2023	210690300	Food sup	ARMAAN DISTRIBUTORS LIMITED	KAMPALA	Uganda	Uganda	.	.	.	https://ww	OPTIMA CONSUMER HEALTH LTD	UK	İngiltere	-	2.770.468,00	UGX
31-07-2023	210690100	Speciall	UG UNLOCKED LIMITED	KAMPALA	Uganda	Uganda	.	.	.	https://ww	UG UNLOCKE LLC	RUBY LANI	Amerika Birleşik Dev	-	11.211,00	UGX
31-07-2023	21069099	Other	E. AKHALWAYA & SONS	.	Güney Afrika Cumhu	South Afri	.	.	.	.	SEASCOPE EXPORTS	158/33 LA	Hindistan	1.145,40	-	USD
31-07-2023	21069090	Outras,	AVELINO INACIO DUARTE	.	Angola	Angola	.	.	.	.	.	.	Güney Afrika Cumhu	1.181,12	1.287,47	USD
31-07-2023	21069099	Autres	SCIEIX LTD	.	Burundi	Burundi	.	.	.	.	ABOURAYA COMPANY	.	Çin	78.044,20	88.897,20	BIF
31-07-2023	21069099	Autres	LIVING WATER INTERNATIONAL	.	Burundi	Burundi	.	.	.	.	ARK BIOSCIENCES PRIVATE LIMITED	.	Güney Afrika Cumhu	5.477.090,00	5.521.030,00	BIF
31-07-2023	210690	Food prep	LESAFFRE IVOIRE	18 BP 1206	Fildişi Sahili	Cote d'Ivoi	.	.	.	https://les	SOCIETE INDUSTRIELLE LESAFFRE	.	Fransa	-	-	
31-07-2023	210690990	210690990	MACI-CANADA	01 BP 1007	Fildişi Sahili	Cote d'Ivoi	.	.	.	http://ma	MISSION ACTION CHARITE INTERNATIONALE	MACI-OPE	Fas	1.530.780,00	1.832.422,00	XOF
31-07-2023	210690900	Préparatic	NEPTUNE OIL	.	Kamerun	Cameroor	.	.	.	https://ne	2CMP INTERNATIONAL TRANSPORT	.	Fransa	100.000,00	-	XAF
31-07-2023	210690960	Food sup	C.H.F. HERON GHANA LTD.	MF BUILDI	Gana	Ghana	.	.	.	https://ww	QUEISSER PHARMA GMBH & CO KG	.	Almanya	230,40	353,90	EUR
31-07-2023	210690960	Food sup	DESI LOPEZ FAFIE	.	Gana	Ghana	.	.	.	.	AMAZON FULFILMENT SERVICES	.	.	198,00	334,10	USD